

LCM Specification

Preliminary specification

Final Specification

Project No. 项目编号	TFT-H017A3CFTST5N10		
Customer 客户名称			
Module No. 客户型号			
Product type 产品内容	TFT LCD Module 128 x 3RGB x 160 Dots 1.77" TFT LCD		
Signature by customer: 客户确认签章:			
<input type="checkbox"/> Trial production		<input type="checkbox"/> Mass production	
编 制	电子审核	结构审核	批 准
Liu.YL			

深圳市鑫洪泰电子科技有限公司

Shenzhen Hot Display Technology Co., Ltd

1 Document revision history :

DOCUMENT REVISION	DATE	DESCRIPTION	PREPARED BY	APPROVED BY
0	2020-04-10	First Release.	Liu.YL	



1. General Feature:

Item	Standard Value	Unit
Display Size	1.77"	--
Number of Pixels	128(H)x3(RGB)*160(V)	--
Active Area	28.032(H) *35.040(V)	mm
Outline Dimension	34.00(H) ×43.70(V)× 2.30(D)	mm
Viewing Direction	12 O'clock	-
Interface	SPI 3/4L	-
Driver IC	ST7735S	-
Driver Condition	VCI=2.8V	V
Backlight	White LED	-
Touch Panel	No Touch Panel	-
Operation Temperature	-20~70	°C
Storage Temperature	-30~80	°C

2.Outline Dimensions

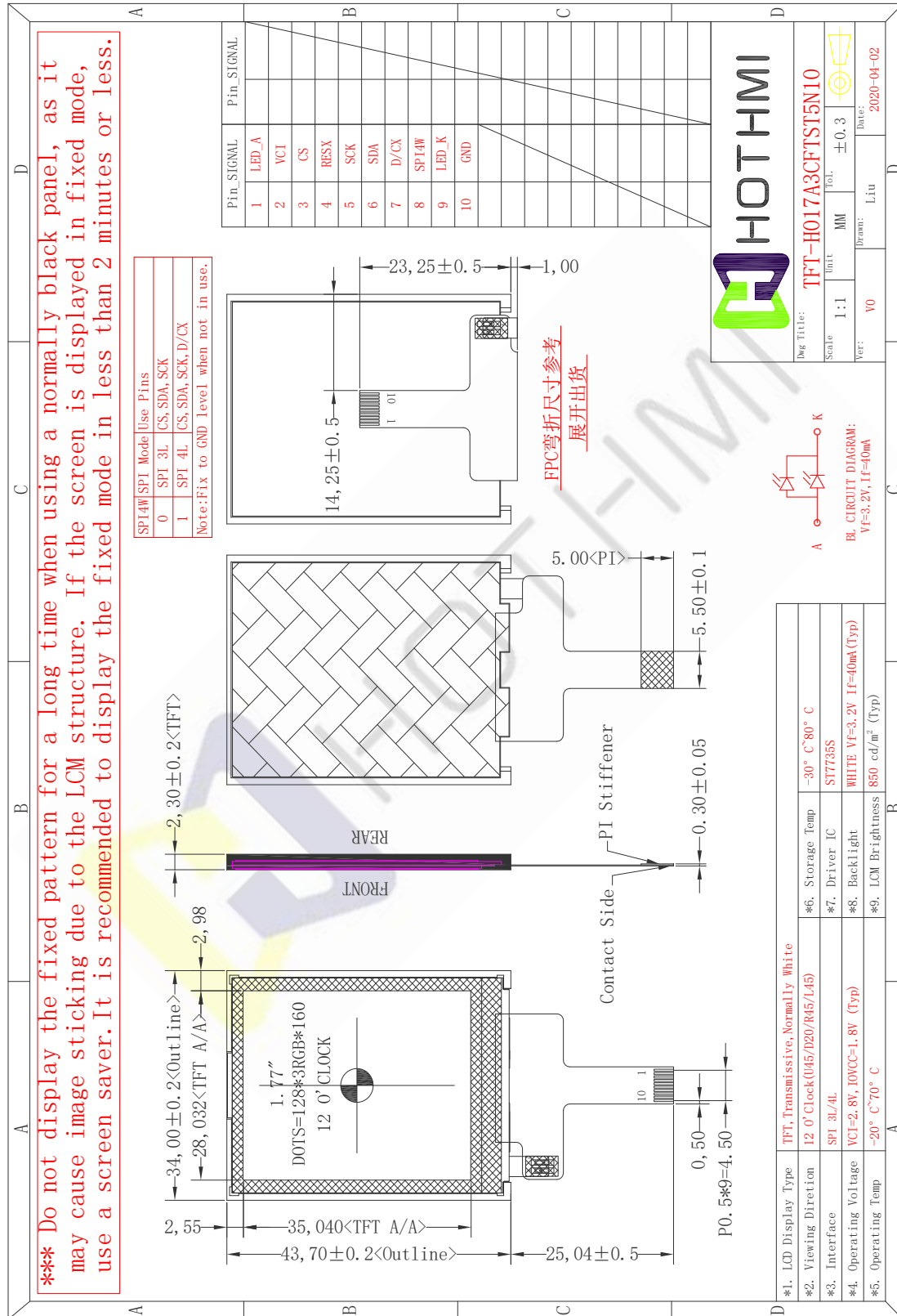

3. Pin Description

3.1 Pin Description

Pin NO.	Symbol	Description
1	LED_A	LED Anode
2	VCI	Analog Power(2.65 ~ 3.3 V)
3	CS	Chip select input pin ("Low" enable).
4	RESX	Reset Pin
5	SCK	Serial interface clock.
6	SDA	SPI interface input pin.
7	D/CX	- Display data/command selection pin. -Fix to GND level when not in use.
8	SPI4W	- SPI4W=' 0' , 3-line SPI Enable. - SPI4W=' 1' , 4-line SPI Enable.
9	LED_K	LED Cathode
10	GND	Ground
---END---		

3.2 Wiring Diagram

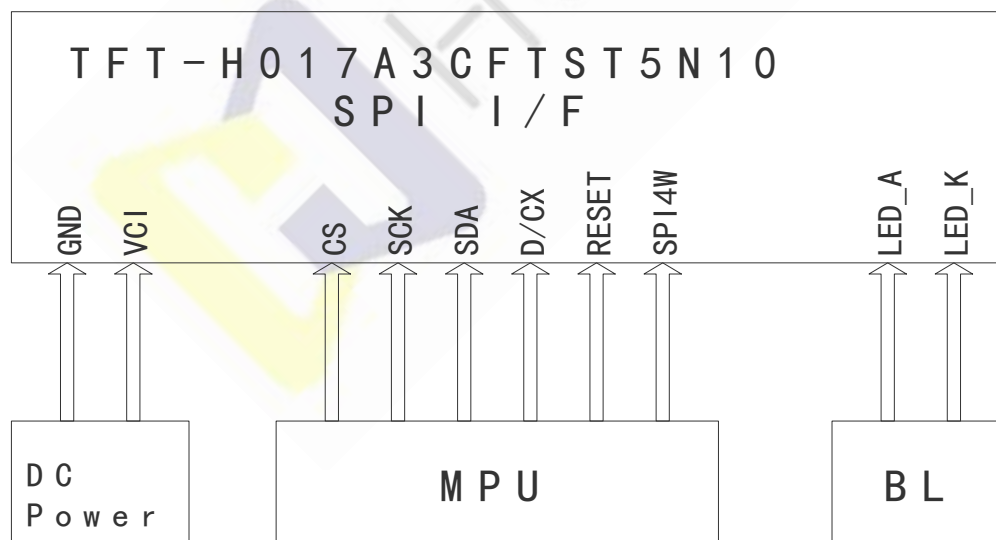

SPI4W	SPI Mode	Use Pins
0	SPI 3L	CS, SDA, SCK
1	SPI 4L	CS, SDA, SCK, D/CX
Note: Fix to GND level when not in use.		

4. Electrical Characteristics

4-1 TFT LCD Module Operating Conditions

Item	Symbol	Condition	Min	Type	Max	Unit
Interface logic circuits	IOVCC	-	1.65	1.80	3.30	V
Analog Power supply	VCI	-	2.50	2.80	3.30	V
TFT Gate on voltage	VGH	-	10.0	-	16.0	V
TFT Gate off voltage	VGL	-	-16.0	-	-10.0	V

4-2 LED back light specification (pera chip)

Item	Symbol	Condition	Min	Type	Max	Unit
Forward voltage	Vt	If=20mA	-	3.2	-	V
Forward current	Ipn	/1-chip	-	40	-	mA
Luminance(With LCD)	Lv	If=40mA	-	850	-	cd/m ²
Luminous color	White					

5.OPTICAL SPECIFICATION

5.1 Overview

The test of Optical specifications shall be measured in a dark room (ambient luminance 1lux and temperature = 25 ± 2°C) with the equipment of Luminance meter system (Goniometer system and TOPCON BM-5) and test unit shall be located at an approximate distance 50cm from the LCD surface at a viewing angle of θ and Φ equal to 0°. The center of the measuring spot on the Display surface shall stay fixed. The backlight should be operating for 30 minutes prior to measurement.

5.2 Optical Specifications

Parameter		Symbol	Condition	Min.	Typ.	Max.	Unit	Remark
Viewing Angle Range	Horizontal	Θ 3	CR>10	-	45	-	Deg.	Note 1
		Θ 9		-	45	-	Deg.	
	Vertical	Θ 12		-	45	-	Deg.	
		Θ 6		-	20	-	Deg.	
Contrast ratio		CR	$\Theta = 0^\circ$	-	300	-		Note2
Color Gamut		CG		-	-		%	
White Chromaticity		Wx			0.308			
		Wy			0.325			
Reproduction of color	Red	Rx	$\Theta = 0^\circ$	-0.02	0.612	+0.02		Note4 (Based on C Light)
		Ry			0.329			
	Green	Gx			0.299			
		Gy			0.567			
	Blue	Bx			0.144			
		By			0.110			
Response Time (Rising + Falling)		Tr+Tf	$\Theta = 0^\circ$ Ta= 25°C	-	30	35	ms	Note5
Transmittance		Tr		-	6.9		%	Note3

Note:

1.Viewing angle is the angle at which the contrast ratio is greater than 10. The viewing angles are determined for the horizontal or 3, 9 o' clock direction and the vertical or 6, 12 o' clock direction with respect to the optical axis which is normal to the LCD surface (see FIGURE 1).

2.Contrast measurements shall be made at viewing angle of $\Theta = 0$ and at the center of the LCD surface. Luminance shall be measured with all pixels in the view field set first to white, then to the dark (black)

state . (see FIGUR 1) Luminance Contrast Ratio (CR) is defined mathematically.

$$CR = \frac{\text{Luminance when displaying a white raster}}{\text{Luminance when displaying a black raster}}$$

3. Transmittance is the Value without APF and without CG.

4. The color chromaticity coordinates specified in the above table shall be calculated from the spectral data measured with all pixels first in red, green, blue and white. Measurements shall be made at the center of the panel.

5. The electro-optical response time measurements shall be made as FIGURE 2 by switching the “data” input signal ON and OFF. The times needed for the luminance to change from 10% to 90% is T_r , and 90% to 10% is T_f .

Figure1 Measurement Set Up

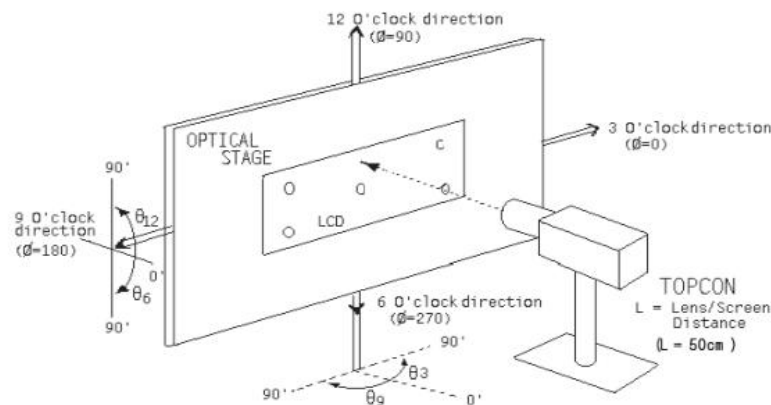
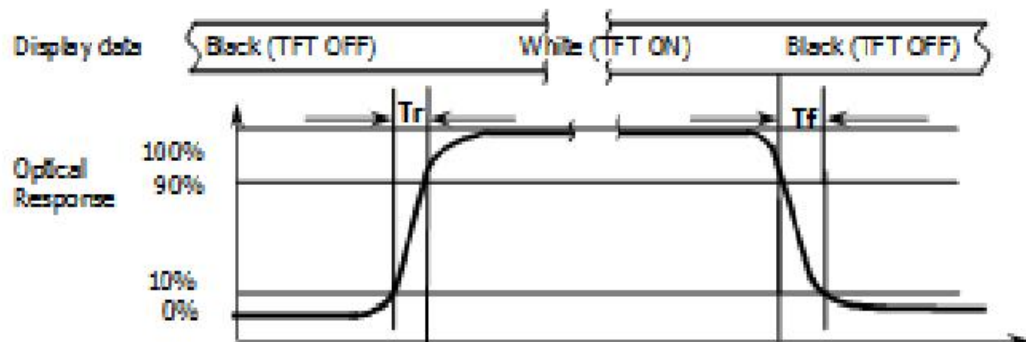
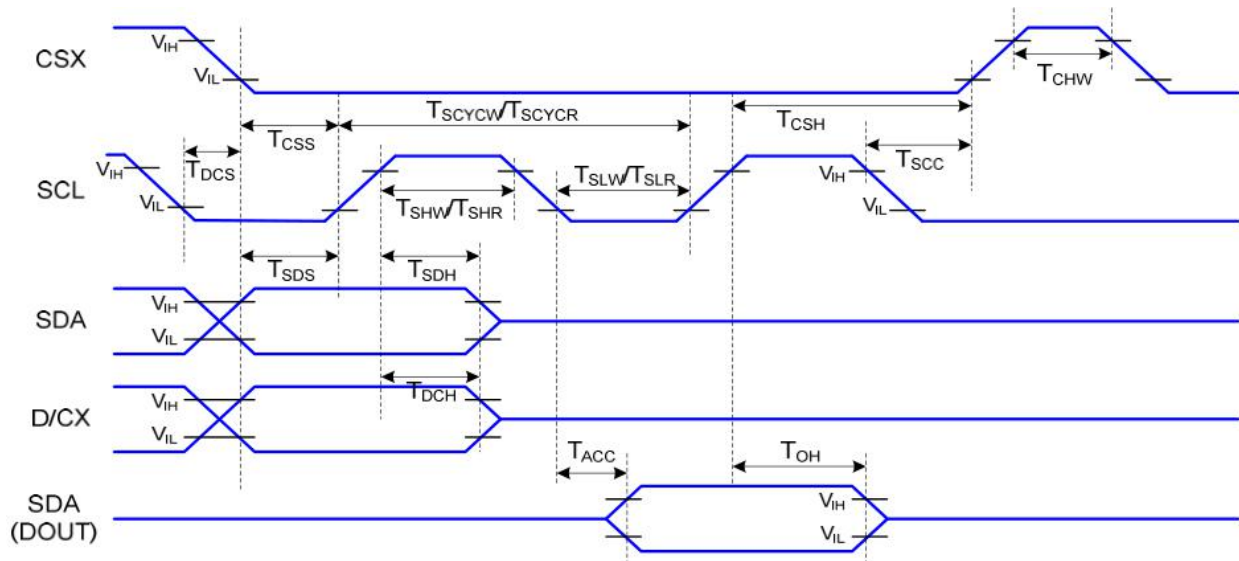

Figure2 Response Time Testing



6. Timing Characteristics of Input Signals

6-1 Serial Interface Characteristics (4-line serial)



Ta=25 °C, VDDI=1.65~3.7V, VDD=2.5~4.8V

Signal	Symbol	Parameter	MIN	MAX	Unit	Description
CSX	TCSS	Chip Select Setup Time (Write)	45		ns	
	TCSH	Chip Select Hold Time (Write)	45		ns	
	TCSS	Chip Select Setup Time (Read)	60		ns	
	TSCC	Chip Select Hold Time (Read)	65		ns	
	TCHW	Chip Select "H" Pulse Width	40		ns	
SCL	TSCYCW	Serial Clock Cycle (Write)	66		ns	-Write Command & Data Ram
	TSHW	SCL "H" Pulse Width (Write)	15		ns	
	TSLW	SCL "L" Pulse Width (Write)	15		ns	
	TSCYCR	Serial Clock Cycle (Read)	150		ns	-Read Command & Data Ram
	TSHR	SCL "H" Pulse Width (Read)	60		ns	
	TSLR	SCL "L" Pulse Width (Read)	60		ns	
D/CX	TDCS	D/CX Setup Time	10		ns	
	TDCH	D/CX Hold Time	10		ns	
SDA (DIN) (DOUT)	TSDS	Data Setup Time	10		ns	For Maximum CL=30pF For Minimum CL=8pF
	TSDH	Data Hold Time	10		ns	
	TACC	Access Time	10	50	ns	
	TOH	Output Disable Time	15	50	ns	

7. RELIABILITY TEST

7-1 Temperature and Humidity

TEST ITEMS	CONDITIONS	NOTE
High Temperature Operation	60°C ; 120hrs	
High Temperature Storage	70°C ; 120hrs	
High Temperature High Humidity Operation	60°C; 90%RH ; 120hrs (No condensation)	
Low Temperature Operation	-10°C ; 120hrs	
Low Temperature Storage	-20°C ; 120hrs	
Thermal Shock	-30°C (0.5hr) ~ 80°C (0.5hr) ; 100 Cycles	Non-Operating
Image Sticking	25°C ; 2hrs	1

Note 1: Condition of Image Sticking test: 25°C ±2°C

Operation with test pattern sustained for 4 hrs, then change to gray pattern immediately. After 5 mins, the mura must be disappeared completely .

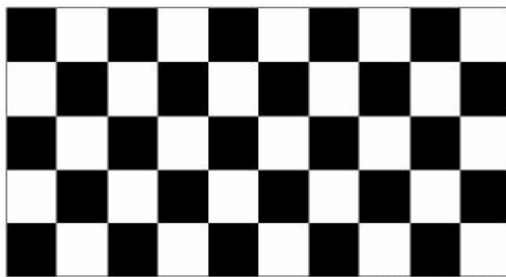

(a) Test Pattern (chess board Pattern)



(b) Gray Pattern

7-2 Shock and Vibration

ITEMS	CONDITIONS
Packing Shock (Non-Operation)	<ul style="list-style-type: none"> ● Shock level:980m/s² ● Waveform:1/2 Sine wave,6msec ● ±X, ±Y ±Z,each axis 1 times
Packing Vibration (Non-Operation)	<ul style="list-style-type: none"> ● Frequency range:8-33.3HZ ● Stoke:1.0mm ● Sweep: 10Hz-50Hz ● x,y,z 2 hours for each direction

7-3 Electrostatic Discharge

TEST ITEM	CONDITIONS
ESD (Non-operation)	150pF,330Ω , Contact±4KV,Air :±8KV.Note 1
	200pF,0Ω , ±200V Contact test.Note 2

Note:Measure Point:

- 1.LCD glass and metal bezel
- 2.IF connector pins

8.HANDDLING & CAUTIONS

8-1 Caution For Operation

◆Since the LCM is made of glass, do not apply strong mechanical impact or static load onto it. Handling with care since shock, vibration, and careless handling may seriously affect the product. If it falls from a high place or receives a strong shock, the glass maybe broken.

◆It is indispensable to drive the LCM within the specified voltage limit since the higher voltage than the limit causes LCM's life shorter. An electro-chemical reaction due to DC causes undesirable deterioration of the LCM so that the use of DC drive should avoid.

◆Do not connect or disconnect the LCM to or from the system when power is on.

◆Never use the LCM under abnormal conditions of high temperature and high humidity.

◆When expose to drastic fluctuation of temperature(hot to cold or cold to hot), the LCM may be affected; specifically, drastic temperature fluctuation from cold to hot, produces dew on the LCM's surface which may affect the operation of the polarizer on the LCM.

◆Response time will be extremely delay at lower temperature than the operating temperature range and on the other hand LCM may turn black at temperature above its operational range. However those phenomenon do not mean malfunction or out of order with the LCM. The LCM will revert to normal operation once the temperature returns to the recommended temperature range for normal operation.

◆ Do not display the fixed pattern for a long time when using a normally black panel, as it may cause image sticking due to the LCM structure. If the screen is displayed in fixed mode, use a screen saver. It is recommended to display the fixed mode in less than 2 minutes or less.

◆Do not disassemble and/or re-assemble LCM module

7-2 Caution Against Static Charge

◆The LCM use C-MOS LSI drivers, so customers are recommended that any unused input terminal would be connected to Vdd or Vss, do not input any signals before power is turn on, and ground you body, work/assembly area, assembly equipments to protect against static electricity.

◆Remove the protective film slowly, keeping the removing direction approximate 30-degree not vertical from panel surface, if possible, under ESD control device like ion blower, and the humidity of working room should be kept over 50%RH to reduce the risk of static charge.

◆Avoid the use work clothing made of synthetic fibers. We recommend cotton clothing or other conductivity-treated fibers.

◆In handling the LCM, wear non-charged material gloves. And the conducting wrist to the earth and the conducting shoes to the earth are necessary

9.LCD display initialization code

```

Void Panel_initial_code(void)
{
    //-----Reset sequence-----//
    LCD_RESET=1;
    Delaysms(1); //Delay 1ms
    LCD_RESET=0;
    Delaysms(10); //Delay 10ms
    LCD_RESET=1;
    Delaysms(120); //Delay 120ms
    //-----//

    WriteComm(0x11);
    Delaysms(120);

    WriteComm(0xB1);
    WriteData(0x05);
    WriteData(0x3C);
    WriteData(0x3C);
    WriteComm(0xB2);
    WriteData(0x05);
    WriteData(0x3C);
    WriteData(0x3C);
    WriteComm(0xB3);
    WriteData(0x05);
    WriteData(0x3C);
    WriteData(0x3C);
    WriteData(0x05);
    WriteData(0x3C);
    WriteData(0x3C);

    WriteComm(0xB4); //Dot inversion
    WriteData(0x03);

    WriteComm(0xC0);
    WriteData(0x28);
    WriteData(0x08);
    WriteData(0x04);
    WriteComm(0xC1);
    WriteData(0XC0);

```

```
WriteComm(0xC2);  
WriteData(0x0D);  
WriteData(0x00);  
WriteComm(0xC3);  
WriteData(0x8D);  
WriteData(0x2A);  
WriteComm(0xC4);  
WriteData(0x8D);  
WriteData(0xEE);
```

```
WriteComm(0xC5); //VCOM  
WriteData(0x1A);
```

```
WriteComm(0x36); //MX, MY, RGB mode  
WriteData(0xc0);
```

```
WriteComm(0xE0);  
WriteData(0x04);  
WriteData(0x22);  
WriteData(0x07);  
WriteData(0x0A);  
WriteData(0x2E);  
WriteData(0x30);  
WriteData(0x25);  
WriteData(0x2A);  
WriteData(0x28);  
WriteData(0x26);  
WriteData(0x2E);  
WriteData(0x3A);  
WriteData(0x00);  
WriteData(0x01);  
WriteData(0x03);  
WriteData(0x13);  
WriteComm(0xE1);  
WriteData(0x04);  
WriteData(0x16);  
WriteData(0x06);  
WriteData(0x0D);  
WriteData(0x2D);  
WriteData(0x26);
```

```
WriteData(0x23);
WriteData(0x27);
WriteData(0x27);
WriteData(0x25);
WriteData(0x2D);
WriteData(0x3B);
WriteData(0x00);
WriteData(0x01);
WriteData(0x04);
WriteData(0x13);

WriteComm(0x3A); //65k mode
WriteData(0x05);
WriteComm(0x29); //Display on
}
```

```
Void Panel_SleepIn_Mode (void)
```

```
{
    WriteComm(0x28);
    Delays(120);
    WriteComm(0x10);
    Delays(120);
}
```

```
Void Panel_SleepOut_Mode (void)
```

```
{
    WriteComm(0x11);
    Delays(120);
    WriteComm(0x29);
    Delays(120);
}
```

```
#define ROW 161
#define COL 130

void DispColor(unsigned int color)
{
    unsigned int i,j;
        CLKSEL = 0x03;
    BlockWrite(2,COL-1,1,ROW-1);
    CS0=0;
    RS=1;

    for(i=0;i<ROW;i++)
    {
        for(j=0;j<COL;j++)
        {
            SendDataSPI(color>>8);
            SendDataSPI(color);
        }
    }
        CLKSEL = 0x00;

    CS0=1;
}

void BlockWrite(unsigned int Xstart,unsigned int Xend,unsigned int Ystart,unsigned int Yend) reentrant
{
    WriteComm(0x2A);
    WriteData(Xstart>>8);
    WriteData(Xstart);
    WriteData(Xend>>8);
    WriteData(Xend);

    WriteComm(0x2B);
    WriteData(Ystart>>8);
    WriteData(Ystart);
    WriteData(Yend>>8);
    WriteData(Yend);

    WriteComm(0x2c);
}
```

10. LCD Test Pattern

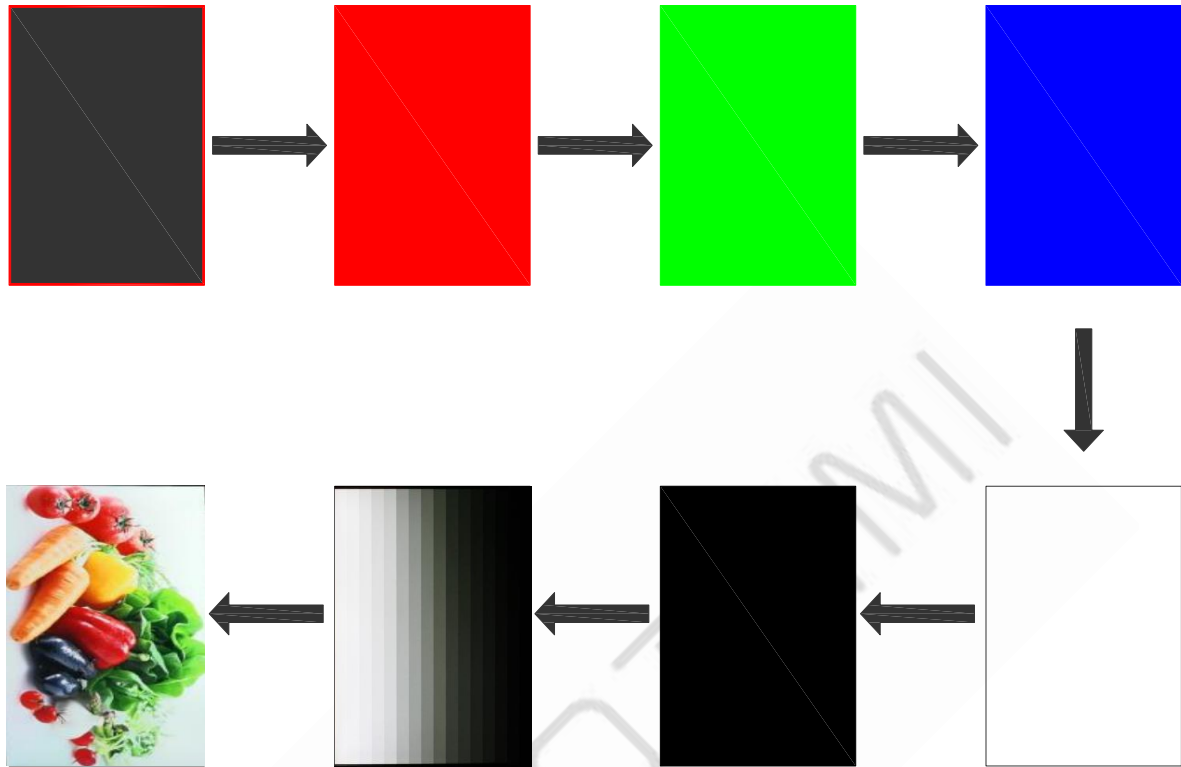

Pattern	Red frame	Red	Green	Blue	White	Black	Gray scale	Image
Current (mA)	T. B. D	T. B. D	T. B. D	T. B. D	T. B. D	T. B. D	T. B. D	T. B. D